



**KERN**<sup>®</sup> *KERN & Sohn GmbH*

# Operating manual

## Baby scale

### **KERN MBA**

Type TMBA-B

Version 1.8

2021-02

GB



TMBA\_B-BA-d-2118

- D** Weitere Sprachversionen finden Sie online unter [www.kern-sohn.com/manuals](http://www.kern-sohn.com/manuals)
- BG** Други езикови версии ще намерите в сайта [www.kern-sohn.com/manuals](http://www.kern-sohn.com/manuals)
- DK** Flere sprogudgaver findes på websiden [www.kern-sohn.com/manuals](http://www.kern-sohn.com/manuals)
- EST** Muud keeleversioonid leiate Te leheküljel [www.kern-sohn.com/manuals](http://www.kern-sohn.com/manuals)
- E** Más versiones de idiomas se encuentran online bajo [www.kern-sohn.com/manuals](http://www.kern-sohn.com/manuals)
- GR** Άλλες γλωσσικές αποδόσεις θα βρείτε στην ιστοσελίδα [www.kern-sohn.com/manuals](http://www.kern-sohn.com/manuals)
- F** Vous trouverez d'autres versions de langue online sous [www.kern-sohn.com/manuals](http://www.kern-sohn.com/manuals)
- LV** Citas valodu versijas atradīsiet vietnē [www.kern-sohn.com/manuals](http://www.kern-sohn.com/manuals)
- FIN** Muut kieliversiot löytyvät osoitteesta [www.kern-sohn.com/manuals](http://www.kern-sohn.com/manuals)
- LT** Kitas kalbines versijas rasite svetainėje [www.kern-sohn.com/manuals](http://www.kern-sohn.com/manuals)
- GB** Further language versions you will find online under [www.kern-sohn.com/manuals](http://www.kern-sohn.com/manuals)
- RO** Alte versiuni lingvistice veți găsi pe site-ul [www.kern-sohn.com/manuals](http://www.kern-sohn.com/manuals)
- I** Trovate altre versioni di lingue online in [www.kern-sohn.com/manuals](http://www.kern-sohn.com/manuals)
- SK** Iné jazykové verzie nájdete na stránke [www.kern-sohn.com/manuals](http://www.kern-sohn.com/manuals)
- NL** Bijkomende taalversies vindt u online op [www.kern-sohn.com/manuals](http://www.kern-sohn.com/manuals)
- SLO** Druge jezikovne različice na voljo na spletni strani [www.kern-sohn.com/manuals](http://www.kern-sohn.com/manuals)
- PT** Encontram-se online mais versões de línguas em [www.kern-sohn.com/manuals](http://www.kern-sohn.com/manuals)
- CZ** Jiné jazykové verze najdete na stránkách [www.kern-sohn.com/manuals](http://www.kern-sohn.com/manuals)
- PL** Inne wersje językowe znajdą Państwo na stronie [www.kern-sohn.com/manuals](http://www.kern-sohn.com/manuals)
- SE** Övriga språkversioner finns här: [www.kern-sohn.com/manuals](http://www.kern-sohn.com/manuals)
- H** A további nyelvi változatok a következő oldalon található: [www.kern-sohn.com/manuals](http://www.kern-sohn.com/manuals)
- HR** Druge jezične verzije su dostupne na stranici: [www.kern-sohn.com/manuals](http://www.kern-sohn.com/manuals)
- NO** Andre språkversjoner finnes det på [www.kern-sohn.com/manuals](http://www.kern-sohn.com/manuals)



# KERN MBA

Version 1.8 2021-02

## Operating manual Baby scale

### Contents

<b>1</b>	<b>Technical data</b> .....	<b>5</b>
<b>2</b>	<b>Declaration of conformity</b> .....	<b>6</b>
2.1	Explanation of the graphic symbols for medical products.....	6
<b>3</b>	<b>Appliance overview</b> .....	<b>9</b>
3.1	Dimensions .....	10
3.2	Overview of display.....	10
3.3	Keyboard overview.....	12
<b>4</b>	<b>Basic Information (General)</b> .....	<b>13</b>
4.1	Specific function.....	13
4.2	Intended use .....	13
4.3	Improper Use / Contraindications.....	14
4.4	Warranty .....	14
4.5	Monitoring of Test Resources.....	15
<b>5</b>	<b>Basic Safety Precautions</b> .....	<b>16</b>
5.1	Pay attention to the instructions in the Operation Manual .....	16
5.2	Personnel training .....	16
5.3	Preventing contamination .....	16
5.4	Preparing for use.....	16
<b>6</b>	<b>Electromagnetic compatibility (EMC)</b> .....	<b>17</b>
6.1	General hints.....	17
6.2	Electromagnetic interferences.....	19
6.2.1	Degradation of performance.....	19
6.3	Electromagnetic noise immunity .....	20
6.3.1	Crucial features of performance .....	23
6.4	Minimum distances .....	23
<b>7</b>	<b>Transport and storage</b> .....	<b>24</b>
7.1	Testing upon acceptance .....	24
7.2	Packaging / return transport .....	24
<b>8</b>	<b>Unpacking, Setup and Commissioning</b> .....	<b>25</b>
8.1	Installation Site, Location of Use.....	25
8.2	Unpacking .....	25
8.3	Scope of delivery.....	25
8.4	Installation.....	26
8.5	Battery operation.....	26
8.6	Mains connection (option).....	29
8.7	Optional equipment mains adapters .....	29
8.8	Initial Commissioning .....	29

<b>9</b>	<b>Operation</b> .....	<b>29</b>
9.1	Weighing .....	29
9.2	Taring.....	30
9.3	Hold function (Standstill function) .....	31
9.4	Auto off (Automatic switch-off function) .....	32
9.5	Using the optional equipment height measuring rod MBA-A01 .....	33
<b>10</b>	<b>Menu</b> .....	<b>34</b>
10.1	Navigation in the menu .....	34
10.2	Menu overview .....	35
<b>11</b>	<b>Error reports</b> .....	<b>36</b>
<b>12</b>	<b>Servicing, maintenance, disposal</b> .....	<b>37</b>
12.1	Cleaning .....	37
12.2	Cleaning / disinfecting .....	37
12.3	Sterilisation .....	37
12.4	Servicing, maintenance .....	37
12.5	Disposal.....	37
<b>13</b>	<b>Instant help</b> .....	<b>38</b>
<b>14</b>	<b>Verification</b> .....	<b>39</b>
14.1	Verification validity period (current status in D) .....	40
<b>15</b>	<b>Adjustment</b> .....	<b>41</b>
<b>16</b>	<b>Equipment (optional)</b> .....	<b>43</b>

## 1 Technical data

<b>KERN</b>	<b>MBA 10K-3M</b>
Item no./ Type	TMBA 15K-3M-B
Weighing range (max)	15 kg
Minimum load (Min)	0.1 kg
Readability (d)	0.005 kg
Verification value (e)	0.005 kg
Reproducibility	0.005 kg
Linearity	0.005 kg
Display	LCD with 25mm high digits
Recommended adjustment weight, not added (class)	15 kg (M1)
Stabilization time (typical)	3 sec.
Warm-up time	10 min
Operating temperature	10° C .... + 40° C
Storage and Transport Environment	-10 to +60°C, and 30% to 90% relative humidity Atmospheric pressure: 700-1060 hPa
Humidity of air	max. 80 % (not condensing)
Atmospheric pressure (kPa)	70kpa-106kpa
Input Voltage	100 V - 240 V, 50 / 60 Hz
Output Voltage power supply	DC 12V/500mA
Battery use	6 x 1,5 V AA
	battery working period: 50 hours
Auto Off	can be adjusted after "30, 60, 180" sec. or "Off" without load change
Dimensions fully mounted (W x D x H) mm	890 x 470 x 175
Baby weighing pan (B x D x H) mm	600 x 260
Weight kg (net)	4.6
Verification in accordance with 2014/31/EU	Class III
Medical product in accordance with 93/42/EEC	Category Im (with measuring function)
Height measuring rod, optional	MBA-A01, Measuring range 40 – 80 cm

---

## 2 Declaration of conformity

---

The current EC/EU Conformity declaration can be found online in:

[www.kern-sohn.com/ce](http://www.kern-sohn.com/ce)



For verified weighing scales (= weighing scales assessed for conformity) a declaration of conformity is included in the scope of delivery.  
Only these balances are medical products.

### 2.1 Explanation of the graphic symbols for medical products



All medical balances with this mark fulfill the following guidelines:

1. 2014/31/EU: Guideline for non-automatic balances
2. 93/42/EC: Guideline for medical products



Balances which carry this mark, are conformity-evaluated as per accuracy class III of the EC-guideline 2014/31/EU.

**WF 202795**

Designation of the serial number of every device, applied at the device and on the packaging

(Number as an example)



Identification of the manufacturing date of the medical product.

(Year and month here as example)

**2021-02**



“Please note the accompanying documents”  
or “Please note operating instructions”



„Observe operating instructions”



„Observe operating instructions



Identification of manufacturer of medical product  
including address

**Kern & Sohn GmbH**  
Ziegelei 1,  
72336 Balingen, Germany  
[www.kern-sohn.com](http://www.kern-sohn.com)



Electro-medical appliance  
with attachment for type B

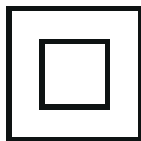

Device protection category II



Dispose of old appliances separately from your  
household waste!

Instead, take them to communal collection points.



Display of supply voltage for scales with polarity display



Supply voltage direct current



Information



To prevent babies lying on the weighing pan from falling off the scale, they must be watched all the time. Please observe note on weighing pan!

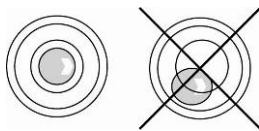

Level balance before use



---

### 3 Appliance overview

---



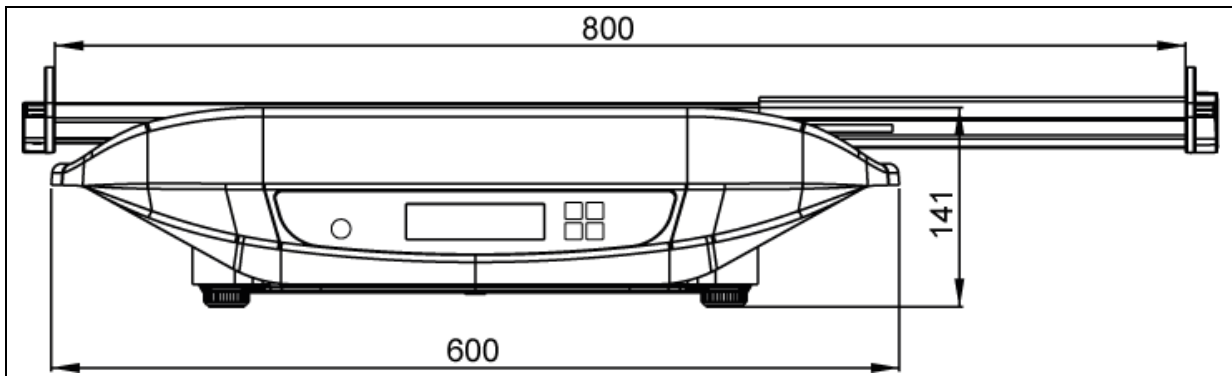

1. Height measuring rod (optional)
2. Baby weighing pan
3. Keyboard
4. LED
5. Bubble level
6. Mains connection
7. Rubber feet (height adjustable)
8. Battery compartment / adjustment switch inside
9. Not documented

### 3.1 Dimensions

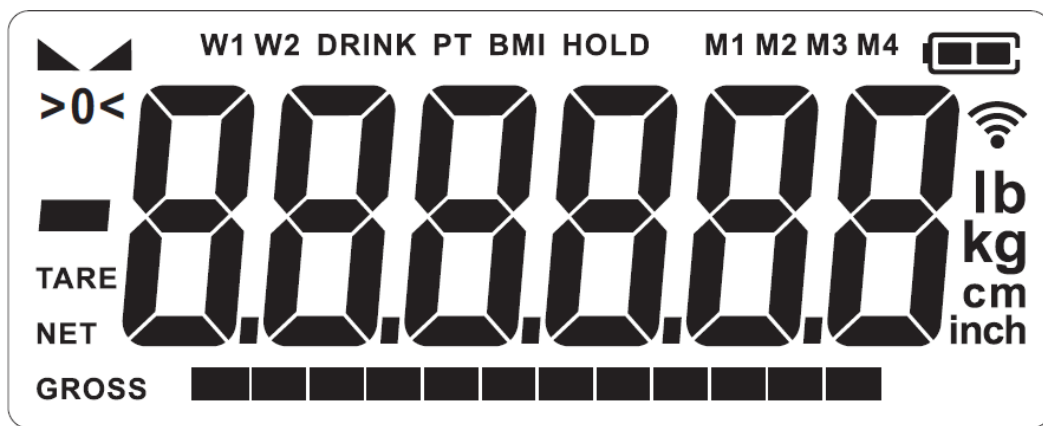

### 3.2 Overview of display







Display	Designation	Description
<b>GROSS</b>	Gross weight display	Illuminated when gross weight of the baby is displayed
<b>NET</b>	Net weight display	Illuminated when net weight of the baby is displayed Illuminated after weighing scale was tared
<b>TARE</b>	Taring display	Illuminated after weighing scale was tared
<b>→0←</b>	Zeroing display	Should the balance not display exactly zero despite empty scale pan, press the  button. Your balance will be set to zero after a short standby time.

	Stability display	Scales are in a steady state
<b>W1 – W2</b>	Display weighing range	Illuminated, when the load is within the displayed range
<b>HOLD</b>	HOLD function	Is displayed with active Hold function
	Rechargeable battery symbol	Lights when the voltage drops below the prescribed minimum.
		Lights when the rechargeable battery capacity is almost exhausted.
		Illuminated when the rechargeable battery is fully charged.

### 3.3 Keyboard overview



Button	Designation	Function
	ON/OFF-button	Turn on/off <b>For numeric entry:</b> <ul style="list-style-type: none"> <li>Decimal point further to the right</li> </ul> <b>In menu:</b> <ul style="list-style-type: none"> <li>Confirm selection</li> </ul>
	HOLD button	Hold function <b>For numeric entry:</b> <ul style="list-style-type: none"> <li>Decimal point further to the left</li> </ul>
	TARE-key/ Zeroing key	<ul style="list-style-type: none"> <li>Tare balance</li> <li>Weighing scale will be reset to „0.0“ kg.</li> </ul> <b>For numeric entry:</b> <ul style="list-style-type: none"> <li>Reduce numeric value</li> </ul> <b>In menu:</b> <ul style="list-style-type: none"> <li>Call up menu</li> <li>Select menu items</li> </ul>
	PRINT button	Printout the weighing value <b>For numeric entry:</b> <ul style="list-style-type: none"> <li>Increase numerical value</li> </ul> <b>In menu:</b> <ul style="list-style-type: none"> <li>Select menu items</li> </ul>

## 4 Basic Information (General)



Balances have to be verified for the purposes stated below in accordance with Directive 2014/31/EU. Article 1, paragraph 4. "Determination of mass in the practice of medicine that is, weighing patients for reasons of medical supervision during medical surveillance, examination and treatment."

### 4.1 Specific function

#### Indication

- Determining the body weight in the medical practice area.
- Operated as "Non-automatic weighing instrument" which means that you have to carefully put the baby in the centre of the weighing pan. Once a steady display value is shown, you can read the weight value.

#### Contraindication

- No contraindication known

### 4.2 Intended use

These balances serve as a means of determining the weight of babies in medical treatment rooms (hospitals or Doctor practices). The frequently used function of the baby scale is recognising, preventing and controlling illnesses.





Scales fitted with a serial interface may only be connected to appliances in compliance with Directive EN60601-1.



To prevent babies lying on the weighing pan from falling off the scale, they must be watched all the time. Please observe note on weighing pan!



### 4.3 Improper Use / Contraindications

	<p>Do not use these scales for dynamic weighing processes. Do not leave permanent load on the weighing pan. This may damage the measuring system.</p> <p>Impacts and overloading exceeding the stated maximum load (max) of the weighing plate, minus a possibly existing tare load, must be strictly avoided. This could cause damage to the balance.</p> <p>Never operate balance in explosive environment. The serial version is not explosion protected. It should be noted that a flammable mixture of anaesthetics and oxygen or laughing gas may occur.</p> <p>The structure of the balance may not be modified. This may lead to incorrect weighing results, safety-related faults and destruction of the balance.</p> <p>The balance may only be used according to the described conditions. Other areas of use must be released by KERN in writing.</p> <p>If the balance is not used for a longer time, take out the batteries and store them separately. Leaking battery liquid could damage the balance.</p> <p>The scale is for weighing baby only. Any person with weight over 15 kg, do not step on the scale.</p>
	<p><b>Improper use of optional height meter MBA-A01:</b></p> <p>The structure of the height measuring rod may not be modified. This may result in incorrect measuring results, safety-related defects as well as destruction.</p> <p>The height measuring rod may only be used according to the described conditions. Other areas of use must be released by KERN in writing. More details in the instruction manuals of the height meter.</p>

### 4.4 Warranty

Warranty claims shall be voided in case of

- Our conditions in the operation manual are ignored
- The appliance is used outside the described uses
- The appliance is modified or opened
- Mechanical damage and damage caused by media, liquids,
- Natural wear and tear
- The appliance is improperly set up or incorrectly electrically connected
- The measuring system is overloaded
- Dropping the balance

#### **4.5 Monitoring of Test Resources**

In the framework of quality assurance the measuring-related weighing properties of the balance and, if applicable, the testing weight, must be checked regularly. The responsible user must define a suitable interval as well as type and scope of this test. Information is available on KERN's home page ([www.kern-sohn.com](http://www.kern-sohn.com)) with regard to the monitoring of balance test substances and the test weights required for this. In KERN's accredited DKD calibration laboratory test weights and balances may be calibrated (return to the national standard) fast and at moderate cost.



For balances with height measuring rods, we recommend a metrological examination of the accuracy of the height measuring rod, however, this is not mandatory as the determination of human body height involves rather large, intrinsic inaccuracies.

---

## 5 Basic Safety Precautions

---

### 5.1 Pay attention to the instructions in the Operation Manual

	⇒ Carefully read this operation manual before setup and commissioning, even if you are already familiar with KERN balances.	
---	---	---

### 5.2 Personnel training

The medical staff must apply and follow the operating instructions for proper use and care of the product.

### 5.3 Preventing contamination

To prevent cross-contamination (fungal skin infections, .....,) clean the baby weighing pan or weighing platform every time after weighing.

Recommendation: After any weighing procedure that could potentially result in contamination (e. g. after weighing that involves direct skin contact).

### 5.4 Preparing for use

- Check the balance for damage before any use
- Maintenance and re-verification  
The baby scale must be serviced and re-verified at regular intervals. (see chapter 12.4)
- Do not use the device on slippery surfaces or in rooms susceptible to vibrations
- The balance must be levelled during installation
- If possible, the product must be transported in its original packaging when transporting. If this is not possible, ensure that the product is protected from damage.







---

## 6 Electromagnetic compatibility (EMC)

---

### 6.1 General hints

The MBA-M is suitable for professional healthcare facility environments (hospital, clinics...).

	The installation and use of this electrical medical device requires special precautionary measures as outlined in the EMC information below.
	Don't near active HF surgical equipment and the RF shielded room of an ME system for magnetic resonance imaging, where the intensity of EM disturbances is high.
	Use of this equipment adjacent to or stacked with other equipment should be avoided because it could result in improper operation. If such use is necessary, this equipment and the other equipment should be observed to verify that they are operating normally.
	Use of accessories, transducers and cables other than those specified or provided by the manufacturer of this equipment could result in increased electromagnetic emissions or decreased electromagnetic immunity of this equipment and result in improper operation.
	Portable RF communications equipment (including peripherals such as antenna cables and external antennas) should be used no closer than 30 cm (12 inches) to any part of the equipment MBA-M, including cables specified by the manufacturer. Otherwise, degradation of the performance of this equipment could result.

**Note :** The emissions characteristics of this equipment make it suitable for use in industrial areas and hospitals (CISPR 11 class A). If it is used in a residential environment (for which CISPR 11 class B is normally required) this equipment might not offer adequate protection to radio-frequency communication services. The user might need to take mitigation measures, such as relocating or re-orienting the equipment.

Electromagnetic compatibility (EMC) describes a device's ability to perform reliably within an electromagnetic environment without causing inadmissible electromagnetic interference at the same time. Amongst other things, such disturbances may be emitted by connecting cables or the air.

Inadmissible disturbances from the environment may result in incorrect displays, inaccurate measured values or incorrect behaviour of the medical device. The line regulation is less than  $\pm 1$ kg unstable readings while measuring at rated weight capacity.

Also in certain cases the baby scale MBA-M may cause such failures in other devices. To eliminate problems of that kind, we recommend you to take one or several of the measures listed below:

- Change the alignment or distance of the device to the source of EMI.
- Install or use the baby scale MBA-M on a place.
- Connect the baby scale MBA-M to another power source.
- For further questions please contact our customer services.

Disturbances may be caused by improper modification or add-ons to the device or not recommended accessories (such as power units or connecting cables). The manufacturer will not be responsible for these. Modifications may also result in a loss of authorisation relating to the use of the device.

Devices emitting high frequency signals (mobile telephones, radio transmitters, radio receivers) may cause interference in the medical device. For that reason do not use them near the medical device. Chapter 6.4 contains details about recommended minimum distances.

## 6.2 Electromagnetic interferences

All necessary instructions for maintaining BASIC SAFETY and ESSENTIAL PERFORMANCE with regard to electromagnetic disturbances for the expected service life. (description according to the product from the manufacturer)

Guidance and manufacturer's declaration -electromagnetic emissions and Immunity  
Use below tables for product using mains power

<b>Guidelines and manufacturer's declaration – electromagnetic emissions</b>	
The baby scale MBA-M is intended to be operated in an electromagnetic environment as defined below. The customer or user of the baby scale MBA-M should ensure that operation takes place in such an environment.	
<b>Emissions test</b>	<b>Compliance</b>
RF emissions CISPR 11	Group 1
RF emissions CISPR 11	Class [A]
Harmonic emissions IEC 61000-3-2	Class A
Voltage fluctuations/ flicker IEC 61000-3-3	Comply

Do not put the baby scale MBA-M directly next to other devices and do not stack it with other devices. If this type of operation is necessary, observe the baby scale MBA-M to ensure normal operation in such an arrangement.

### 6.2.1 Degradation of performance

	Strong fields of electromagnetic interferences caused for example by electric motors or inductive charging devices may lead to degradation of performance when placed next to the baby scale MBA-M. Degradation of performance may lead to unstable displayed weighing values.
---	--

### 6.3 Electromagnetic noise immunity

<b>Guidelines and manufacturer's declaration - electromagnetic immunity</b>		
The baby scale MBA-M is intended to be operated in an electromagnetic environment as defined below. The customer or user of the baby scale MBA-M should ensure that operation takes place in such an environment.		
<b>Immunity tests</b>	<b>IEC 60601-1-2 Test level</b>	<b>Compliance level</b>
Electrostatic discharge (ESD) IEC 61000-4-2	± 8 kV contact ± 2 kV, ± 4 kV, ± 8 kV, ± 15kV air	± 8 kV contact ±2 kV, ± 4 kV, ±8kV, ±15kV air
Electrical fast transient / burst IEC 61000-4-4	± 2 kV for power supply lines ± 1 kV signal input/output 100kHz repetition frequency	± 2 kV for power supply lines Not applicable 100kHz repetition frequency
Surge IEC 61000-4-5	±0.5 kV, ±1 kV differential mode ±0.5 kV, ±1 kV, ±2 kV common mode	±0.5 kV, ±1 kV differential mode Not Applicable
Voltage dips, short interruptions and voltage variations on power supply input lines IEC 61000-4-11	0 % UT; 0,5 cycle. At 0°, 45°, 90°, 135°, 180°, 225°, 270° and 315°. 0 % UT; 1 cycle and 70 % UT; 25/30 cycles; Single phase: at 0°. 0 % UT; 250/300 cycle	0 % UT; 0,5 cycle. At 0°, 45°, 90°, 135°, 180°, 225°, 270° and 315°. 0 % UT; 1 cycle and 70 % UT; 25/30 cycles; Single phase: at 0°. 0 % UT; 250/300 cycle

Power frequency magnetic field IEC 61000-4-8	30 A/m 50Hz/60Hz	30 A/m 50Hz/60Hz
Conducted RF IEC61000-4-6	3 V 0,15 MHz – 80 MHz 6 V in ISM band between 0,15 MHz and 80 MHz 80 % AM at 1 kHz	3 V 0,15 MHz – 80 MHz 6 V in ISM band between 0,15 MHz and 80 MHz 80 % AM at 1 kHz
Radiated RF IEC61000-4-3	10 V/m 80 MHz – 2,7 GHz 80 % AM at 1 kHz	10 V/m 80 MHz – 2,7 GHz 80 % AM at 1 kHz 
NOTE $U_T$ equals AC line voltage prior to application of test level.		

<b>Guidance and manufacturer's declaration - electromagnetic Immunity</b>							
	<b>Test Frequency (MHz)</b>	<b>Band (MHz)</b>	<b>Service</b>	<b>Modulation</b>	<b>Modulation (W)</b>	<b>Distance (m)</b>	<b>IMMUNITY TEST LEVEL (V/m)</b>
Radiated RF IEC61000-4-3 (Test specifications for ENCLOSURE PORT IMMUNITY to RF wireless communications equipment)	385	380 – 390	TETRA 400	Pulse modulation 18 Hz	1,8	0.3	27
	450	430 – 470	GMRS 460, FRS 460	FM ± 5 kHz deviation 1 kHz sine	2	0.3	28
	710	704 – 787	LTE Band 13, 17	Pulse modulation 217 Hz	0,2	0.3	9
	745						
	780						
	810	800 – 960	GSM 800/900, TETRA 800, iDEN 820, CDMA 850, LTE Band 5	Pulse modulation 18 Hz	2	0.3	28
	870						
	930						
	1720	1 700 – 1 990	GSM 1800; CDMA 1900; GSM 1900; DECT; LTE Band 1, 3, 4, 25; UMTS	Pulse modulation 217 Hz	2	0.3	28
	1845						
	1970						
	2450	2 400 – 2 570	Bluetooth, WLAN, 802.11 b/g/n, RFID 2450, LTE Band 7	Pulse modulation 217 Hz	2	0.3	28
	5240	5 100 – 5 800	WLAN 802.11 a/n	Pulse modulation 217 Hz	0,2	0.3	9
	5500						
	5785						

<sup>a</sup> The field intensity of stationary radio transmitters such as base stations of wireless telephones and mobile radio sets, amateur radio stations, AM and FM radio and television stations cannot be reliably predicted in advance. To determine the electromagnetic environment in respect of stationary transmitters, you should consider a study of electromagnetic phenomena at the location. If the measured field intensity at the location where the baby scale MBA-M is to be used exceeds the conformity level above, you should observe the baby scale MBA-M in order to ensure normal operation. If you observe unusual features of performance you may have to take additional measures such as a change in alignment or a different location for the medical device.

**Note :** The EMISSIONS characteristics of this equipment make it suitable for use in industrial areas and hospitals (CISPR 11 class A). If it is used in a residential environment (for which CISPR 11 class B is normally required) this equipment might not offer adequate protection to radio-frequency communication services. The user might need to take mitigation measures, such as relocating or re-orienting the equipment.

### 6.3.1 Crucial features of performance

	<p>The baby scale MBA-M does not have any crucial features of performance as per IEC 60601-1. The system may be subject to interference by other devices even if these devices conform to current emission requirements as per CISPR.</p>
---	---

### 6.4 Minimum distances

<b>Recommended safety distances between portable and mobile HF telecommunication devices and the medical device</b>			
<p>The baby scale MBA-M is designed for use in an electromagnetic environment in which HF disturbance variables are controlled. The customer or user of the baby scale MBA-M can help avoiding electromagnetic disturbances by keeping the minimum distance between portable and mobile HF telecommunication devices (transmitters) and the medical device – depending on the output performance of the communication device, as stated below.</p>			
Rated capacity of transmitter W	Safety distance depending on the transmission frequency m		
	150 kHz to 80 MHz $d = 1.2\sqrt{P}$	80 MHz to 800 MHz $d = 1.2\sqrt{P}$	800 MHz to 2.5 GHz $d = 2.3\sqrt{P}$
0.01	0.12	0.12	0.23
0.1	0.38	0.38	0.73
1	1.20	1.20	2.30
10	3.80	3.80	7.30
100	12.00	12.00	23.00
<p>For transmitters with a maximum rated capacity not stated in the table above you can calculate the recommended safety distance in metres (m) yourself by using the equation belonging to each column, whereby P equals the maximum rated capacity of the transmitter in Watt (W) as per details provided by the transmitter manufacturer.</p> <p>NOTE 1 Higher frequency range applies to 80 MHz and 800 MHz. NOTE 2 These guidelines may not be applicable in all cases. The spread of electromagnetic variables is influenced by absorption and reflections in buildings, objects and humans.</p>			

---

## 7 Transport and storage

---

### 7.1 Testing upon acceptance

When receiving the appliance, please check packaging immediately, and the appliance itself when unpacking for possible visible damage.

### 7.2 Packaging / return transport



- ⇒ Keep all parts of the original packaging for a possibly required return.
- ⇒ Only use original packaging for returning.
- ⇒ Prior to dispatch disconnect all cables and remove loose/mobile parts.
- ⇒ Reattach possibly supplied transport securing devices.
- ⇒ Secure all parts such as the weighing pan, power unit etc. against shifting and damage.



---

## 8 Unpacking, Setup and Commissioning

---

### 8.1 Installation Site, Location of Use

The balances are designed in a way that reliable weighing results are achieved in common conditions of use. You will work accurately and fast, if you select the right location for your balance.

**On the installation site observe the following:**

- Place scales on a stable, even surface
- Avoid extreme heat as well as temperature fluctuation caused by installing next to a radiator or in the direct sunlight;
- Protect the balance against direct draughts due to open windows and doors;
- Avoid jarring during weighing;
- Protect the balance against high humidity, vapours and dust;
- Do not expose the device to extreme dampness for longer periods of time. Non-permitted condensation (condensation of air humidity on the appliance) may occur if a cold appliance is taken to a considerably warmer environment. In this case, acclimatize the disconnected appliance for ca. 2 hours at room temperature.
- Avoid static charge of the balance and of the person to be weighed.
- Avoid contact with water.

Major display deviations (incorrect weighing results) may be experienced should electromagnetic fields (e.g. due to mobile phones or radio equipment), static electricity accumulations or instable power supply occur. In that case, the location must be changed.

### 8.2 Unpacking

Take the balance out of their packaging and place it at the intended position. When using the power pack, ensure that the power cable does not produce a risk of stumbling.

### 8.3 Scope of delivery

- Balance
- Batteries 6x1.5 V AA
- Operating manual

## 8.4 Installation

Carefully remove the balance from the packaging, remove plastic cover and setup balance at the intended workstation.

### Levelling

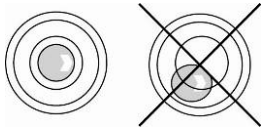

Level balance with foot screws until the air bubble of the water balance is in the prescribed circle.

## 8.5 Battery operation

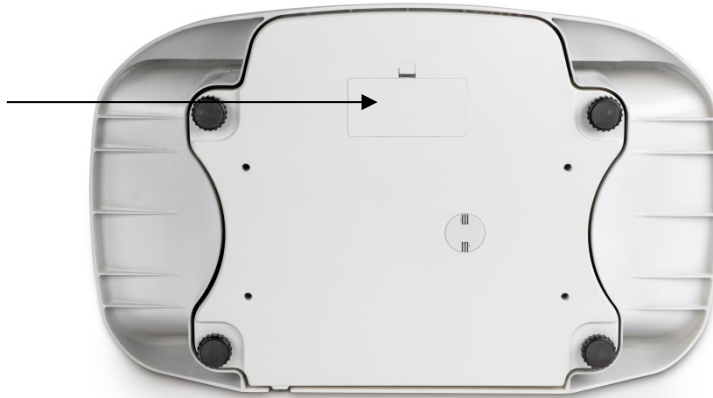

The balance offers also the possibility to be operated with 6x AA-batteries. Open the battery cover (see fig.) at the lower side of the display unit and insert the batteries according to the example shown below. Lock again the battery compartment cover. If the batteries are empty, in the balance display appears the symbol . Change batteries. To save the battery, the balance switches automatically off (see chap.11.6 Auto off).



If the batteries are run down, to turn off, press the button and immediately change the batteries.

If the balance is not used for a longer time, take out the batteries and store them separately. Leaking battery liquid could damage the balance.



Capacity of batteries exhausted.



Batteries will soon be flat.



Batteries completely loaded



If the balance is not used for a longer time, take out the batteries and store them separately. Leaking battery liquid could damage the balance.

**Insert batteries:**

Remove the battery compartment lid on the lower side of the balance



Connect the battery block with batteries to the contact of the housing and insert into the battery compartment.  
Fix it using the battery compartment lid.



## 8.6 Mains connection (option)

Power is supplied by the external power unit which also serves to isolate the mains supply from the scale. The stated voltage value must be the same as the local voltage.

Only approved genuine KERN power supply units may be used in compliance with Directive EN 60601-1.

## 8.7 Optional equipment mains adapters

Available mains adapters (optional)

- YKA-43
- YKA-44

## 8.8 Initial Commissioning

In order to obtain exact results with the electronic balances, your balance must have reached the operating temperature (see warming up time chap.1). During this warming up time the balance must be connected to the power supply (mains, accumulator or battery) and be switched on.

The accuracy of the balance depends on the local acceleration of gravity.  
The value of gravity acceleration is shown on the type plate.

---

# 9 Operation

---

## 9.1 Weighing

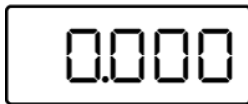

Start balance by pressing .

The balance carries out a self-test.  
The scales are ready for operation as soon as the weight display for "0.000 kg" has appeared.



- However, you can reset the weighing scale to zero by pressing



the  key.

Put baby in the centre of the weighing pan.  
Wait for the stability display , then read the weighing result.



- If the baby is heavier than the max. weighing range, the display shows "oL" (=overload) and a beep sounds.

## 9.2 Taring

The tare weight of any preloads can be deducted by pressing a button so that the actual weight of the baby is displayed in subsequent weighings.

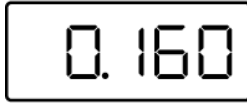

(example)

Put object (such as towel or padding) on the weighing pan.

Wait for stability display  .

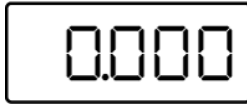

Press  , the zero display appears.

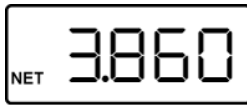

(example)

Put baby on the weighing pan.

Wait until the stability display  appears, then read the weighing result. "NET" is shown at the bottom on the left.



- When the balance is unloaded the saved taring value is displayed with negative sign.
- To delete the stored tare value, unload the balance and press



### 9.3 Hold function (Standstill function)

The balance has an integrated standstill function (mean value calculation). This allows one to weigh the baby exactly, even if it is not restful in the weighing pan.

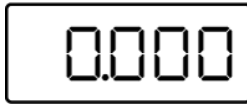

Start balance by pressing



Await zero display

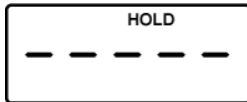

Place the baby, press



“-----“ will shortly be displayed and the HOLD symbol appears flashing. During this time the weight is calculated.



After that the weight of the baby is displayed and "frozen". The HOLD symbol is not more flashing.





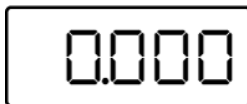



(example)

After unloading the balance, the weighing value is kept for 10 sec. in the display, the HOLD symbol flashes again during this time. Then the balance returns automatically into the weighing mode. The “HOLD” symbol disappears.

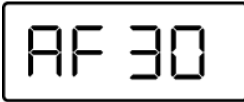

#### 9.4 Auto off (Automatic switch-off function)

The balance offers the possibility of an automatic switch-off. It can be adjusted: Selectable between 30, 60, 180 sec. and off.

	<p>Switch-on the balance, in weighing mode press  for approx. 3 sec.; <b>AF</b> will be displayed.</p>
  	<p>Press , the switch-off time set as last will be displayed, e.g. "30"</p> <p>Press  or  to set the desired switch-off time, e.g. "180" sec.</p> <p>Acknowledge by . The balance changes into the weighing mode, the set switch-off time now is saved.</p>



## 9.5 Using the optional equipment height measuring rod MBA-A01

The scale has the ability to determine not only the weight but also the body height using the optional height measuring rod.

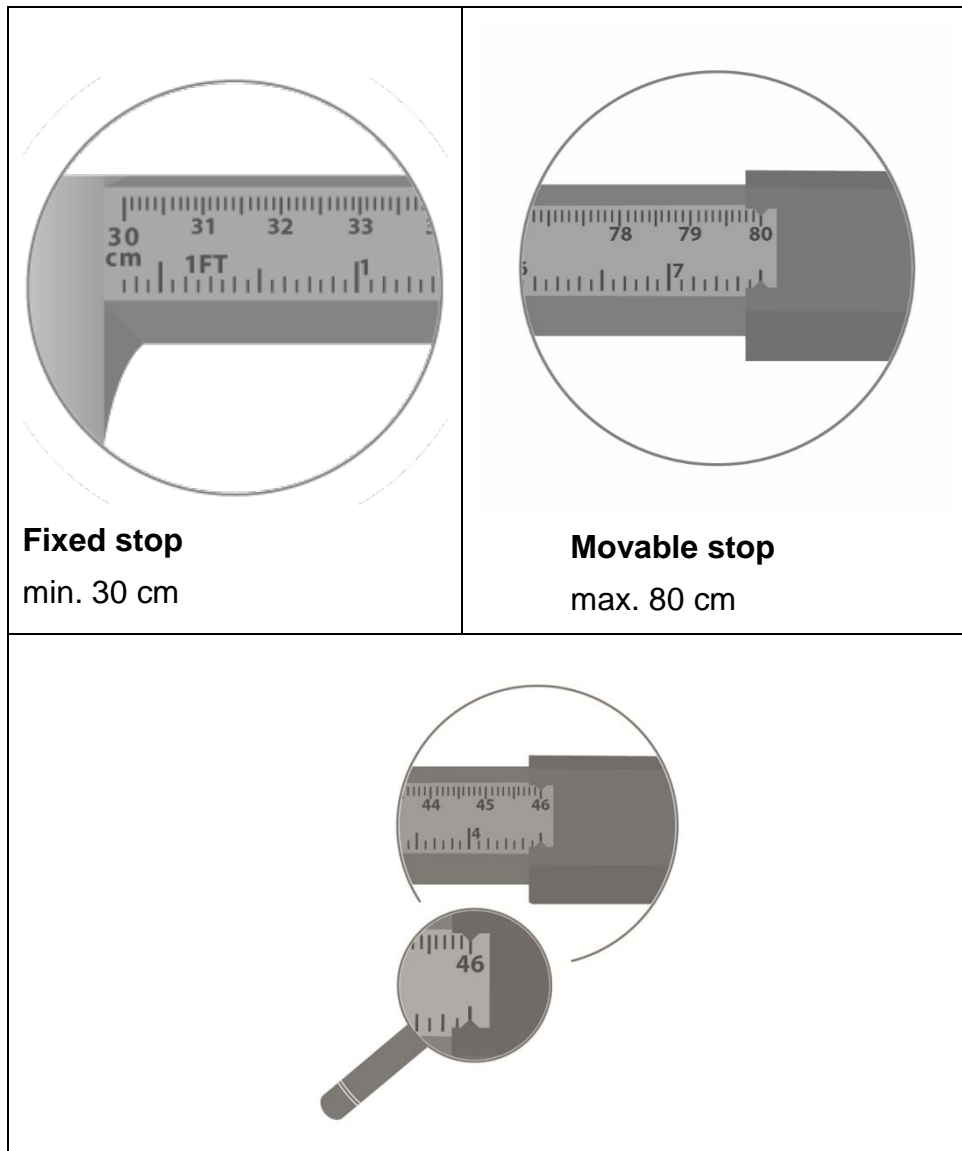

For this purpose proceed as follows:

- ⇒ Position the baby in a way that the head touches gently the fixed stop.
- ⇒ Push the movable stopper carefully till to the heel stopper.
- ⇒ Read the body height.



For further information (for example, installation), refer to the instruction manual that comes with the height measurement.

---

## 10 Menu

---



Access to service menu “tCH” is locked in verified balances. To disable the access lock, destroy the seal mark and actuate the adjustment switch. For position of adjustment switch, see chap. 13.

**Attention:**

After destruction of the seal the weighing system must be re-verified by an authorised agency and a new verification wire/seal mark fitted before it can be reused for applications subject to verification.

### 10.1 Navigation in the menu

#### Call up menu





- ⇒ Switch-on the balance, in weighing mode press  for approx. 3 sec., until the first function **AF** appears.

#### Select function

- ⇒ With help of  or , the individual functions can be selected one after the other.



#### Change settings

- ⇒ Confirm selected function by . The current setting will be displayed.

- ⇒ Select desired setting with  or  and acknowledge by  or reject with .

#### Exit menu/

#### Return to weighing mode

- ⇒ Press , **Exit** will be displayed. Press , the balance returns into the weighing mode.

## 10.2 Menu overview

Function	Settings	Description
<b>AF</b> Automatic shutdown Auto off	AF oFF	Automatic shutdown switched off
	AF 30	Automatic shutdown after 30 min.
	AF 60	Automatic shutdown after 60 min.
	AF 180	Automatic shutdown after 180 min.
<b>rSt</b> reset to factory setting		Reset weighing scale to factory setting

---

## 11 Error reports

---

### Display

### Description



#### Zero range exceeded

(on start-up or when pressing the  key)

- Load on weighing pan
- Excess load, during zero setting of weighing scale
- Incorrect adjusting process
- Fault on load cell



#### Battery capacity exhausted

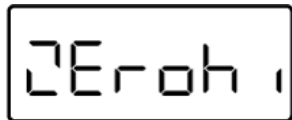

#### Zero range exceeded

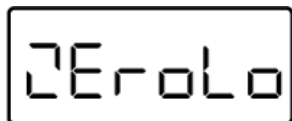

#### Zero setting range not achieved



#### Adjustment error

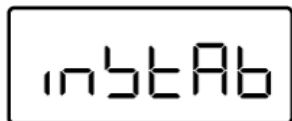

#### Load instable

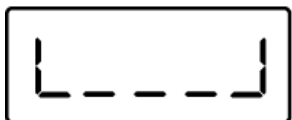

#### Underload

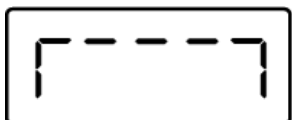

#### Overload

Should other error messages occur, switch balance off and then on again. If the error message remains inform manufacturer.

---

## 12 Servicing, maintenance, disposal

---

### 12.1 Cleaning



Before any maintenance, cleaning and repair work disconnect the appliance from the operating voltage.

### 12.2 Cleaning / disinfecting

Clean weighing platform (such as seat) as well as casing with household detergents or commercially available disinfectants, e.g. 70% isopropanol. We recommend a disinfectant suitable for wiping disinfection. Please follow manufacturer's instructions.

Do not use abrasive or aggressive cleaners such as spirits or alcohol or similar as they might damage the high-quality surface.

To prevent cross-contamination (fungal skin infection) please observe the following time intervals for disinfection:

- Weighing plate before and after any measurement with direct skin contact
- When required:
  - Display
  - Touch-sensitive keyboard



Do not spray disinfectants onto appliance.

Make sure that disinfectant does not penetrate the interior of the balance.

Remove dirt immediately.

### 12.3 Sterilisation

Sterilisation of the appliance not allowed.

### 12.4 Servicing, maintenance

The appliance may only be opened by trained service technicians who are authorized by KERN.

We recommend a regular safety-related technical check (STK).

Disconnect the scales before opening.

### 12.5 Disposal

Disposal of packaging and appliance must be carried out by operator according to valid national or regional law of the location where the appliance is used.

---

## 13 Instant help

---

In case of a fault in the program sequence, the balance should be shortly switched off. The weighing process must then be restarted from the beginning.

### Failure:

### Possible causes:

The displayed weight does not glow.

- The balance is not switched on.
- The mains supply connection has been interrupted (mains cable not plugged in/faulty).
- Power supply interrupted.
- The rechargeable battery / the battery is/ are inserted incorrectly or empty
- No rechargeable battery / no battery is/ are inserted

The displayed weight is permanently changing

- Draught/air movement
- Table/floor vibrations
- The weighing pan is in contact with foreign bodies or is not correctly positioned.
- Electromagnetic fields/ static charging (choose different location/switch off interfering device if possible).

The weighing result is obviously incorrect

- The display of the balance is not at zero.
- Adjustment is no longer correct.
- Great fluctuations in temperature.
- The balance is on an uneven surface.
- Electromagnetic fields / static charging (choose different location/switch off interfering device if possible)

Should other error messages occur, switch balance off and then on again. If the error message remains inform manufacturer.

---

## 14 Verification

---

### General:

According to EU directive 2014/31/EU balances must be officially verified if they are used as follows (legally controlled area):

- a) For commercial transactions if the price of goods is determined by weighing.
- b) For the production of medicines in pharmacies as well as for analyses in the medical and pharmaceutical laboratory.
- c) For official purposes
- d) For manufacturing final packages
- e) Determination of mass in the practice of medicine that is, weighing patients for reasons of medical supervision during medical surveillance, examination and treatment,

In cases of doubt, please contact your local trade in standard.

### Verification notes:

An EU type approval exists for balances described in their technical data as verifiable. If a balance is used where obligation to verify exists as described above, it must be verified and re-verified at regular intervals.

Re-verification of a balance is carried out according to the respective national regulations. For verification validity period, s. chap. 16.1.

The legal regulation of the country where the balance is used must be observed!



#### **Verification of the balance is invalid without the seal.**

The seal marks attached on balances with type approval point out that the balance may only be opened and serviced by trained and authorised specialist staff. If the seal mark is destroyed, verification loses its validity. Please observe all national laws and legal regulations. In Germany a re-verification will be necessary.

### Balances with obligation to verify must be taken out of operation if:

- **The weighing result of the balance is outside the error limit.** Therefore, in regular intervals load balance with known test weight (ca. 1/3 of the max. load) and compare with displayed value.
- **The reverification deadline** has been exceeded.

**Position adjustment switch and seals:**

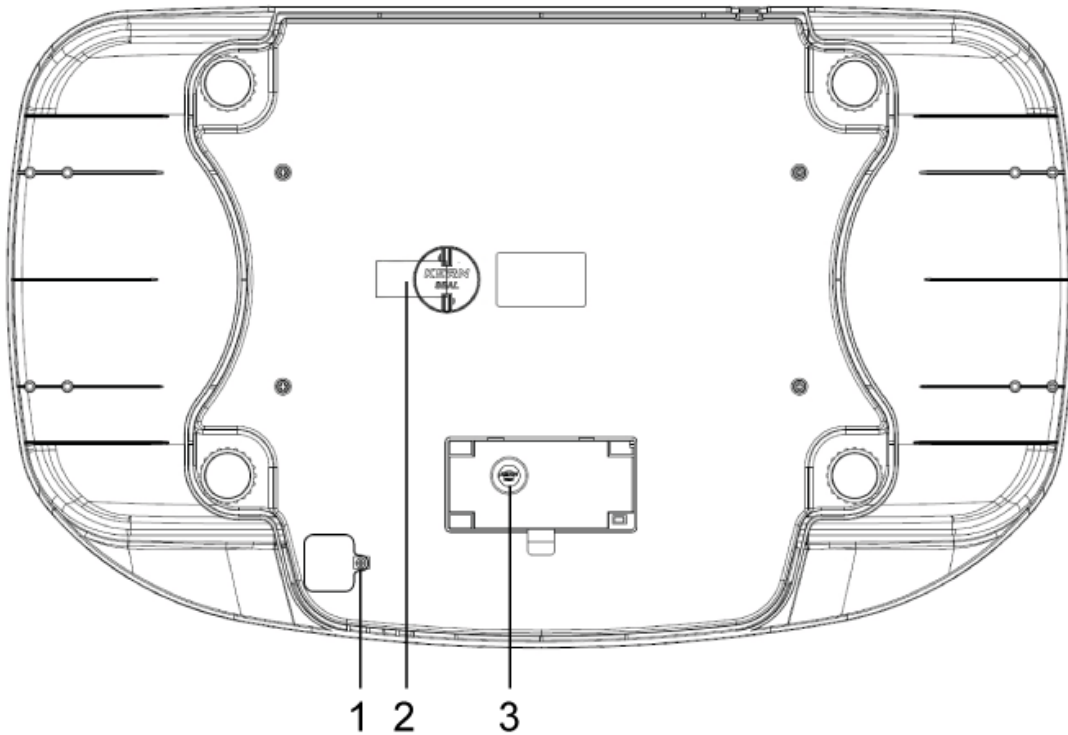

1. Self-destroying seal mark
2. Self-destroying seal mark
3. Sealing mark, adjustment switch below it

**14.1 Verification validity period (current status in D)**

Personal scales (including chair and wheelchair scales) in hospitals	4 years
Personal scales, when not located in hospitals (for example, doctor's offices and nursing homes)	unlimited
Baby weighing scales and mechanical birth weight scales	4 years
Bed scales	2 years
Scales in dialysis stations	unlimited

Also rehab clinics and health authorities are treated as hospitals (4 years of verification validity)

Not treated as hospitals (verification validity not limited) are dialysis stations, nursing homes and doctor's surgeries.

(Data source: "Bureau of Standards News, Weighing Instruments in Medicine" Orig. title „Die Eichverwaltung informiert, Waagen in der Heilkunde“)



---

## 15 Adjustment

---

As the acceleration value due to gravity is not the same at every location on earth, each display unit with connected weighing plate must be coordinated - in compliance with the underlying physical weighing principle - to the existing acceleration due to gravity at its place of location (only if the weighing system has not already been adjusted to the location in the factory). This adjustment process must be carried out for the first commissioning, after each change of location as well as in case of fluctuating environment temperature. To receive accurate measuring values it is also recommended to adjust the display unit periodically in weighing operation.



- Prepare the required adjustment weight. The adjustment weight to be applied depends on the capacity of a weighing scale, see chap. 1. Carry out adjustment as closely as possible to admissible maximum load of weighing scale. Info about test weights can be found on the Internet at: <http://www.kern-sohn.com>.
- Observe stable environmental conditions. For warm-up time required for stabilisation see chap. 1.

















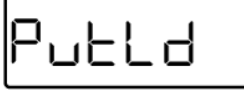

Access to service menu “tCH” is locked in verified balances.  
To disable the access lock, destroy the seal mark and actuate the adjustment switch. Position of the adjustment switch see chap. 13.

**Attention:**

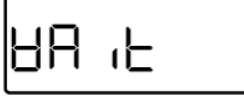
After destruction of the seal mark the weighing system must be re-verified by an authorised agency and a new seal mark fitted before it can be reused for applications subject to verification.

**Procedure:**

 <p style="text-align: center;">↓</p> 	<p>Switch on balance  <b>Operate adjustment switch; for position see chap.14</b>          The balance is now in service menu.</p>
	<p>Press  or  repeatedly until <b>cAL E</b> appears</p>
 <p style="text-align: center;">(example)</p>	<p>Confirm with , the adjustment weight selected as last is displayed, e.g. <b>5000 kg</b></p>
 <p style="text-align: center;">(example)</p>	<p>Select desired setting with  or  and acknowledge by .</p>
 	<p><b>Put Ld</b> is shortly displayed, the first adjustment point <b>0.000 kg</b> is displayed.</p> <p>Unload the balance and confirm with .</p>
 <p style="text-align: center;">↓</p>  <p style="text-align: center;">↓</p>  <p style="text-align: center;">(example)</p>	<p><b>WAit</b>, followed by <b>Put Ld</b> is displayed, followed by the set adjustment weight.</p> <p>Place the adjustment weight, confirm with .</p> <p>The adjustment is carried out, after that the balance switches off automatically.</p>

An adjusting error or incorrect adjustment weight will generate an error message (“Err 4”), repeat the adjustment process.

## 16 Equipment (optional)

Item number	Type number	Product
MBA-A01	TMBA-A01-A	Height measuring rod
YKA-43	TYKA-43-A	Power supply unit (EU/UK/CH)
YKA-44	TYKA-44-A	Power supply unit (EU)

PROMAT (HK) Limited 寶時 (香港) 有限公司

☎ : 2661 2392 ☎ : 5196 8860 ✉ : info@promat.hk 🌐 : http://www.promat.hk

